

Door width calculation/Türbreitenberechnung

W:Door opening width

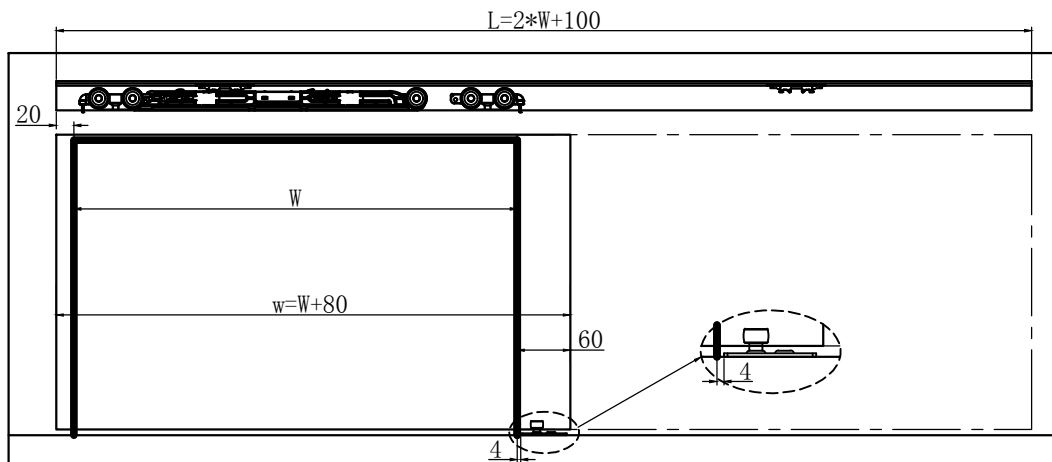

Installation instruction/Einbau Anleitung

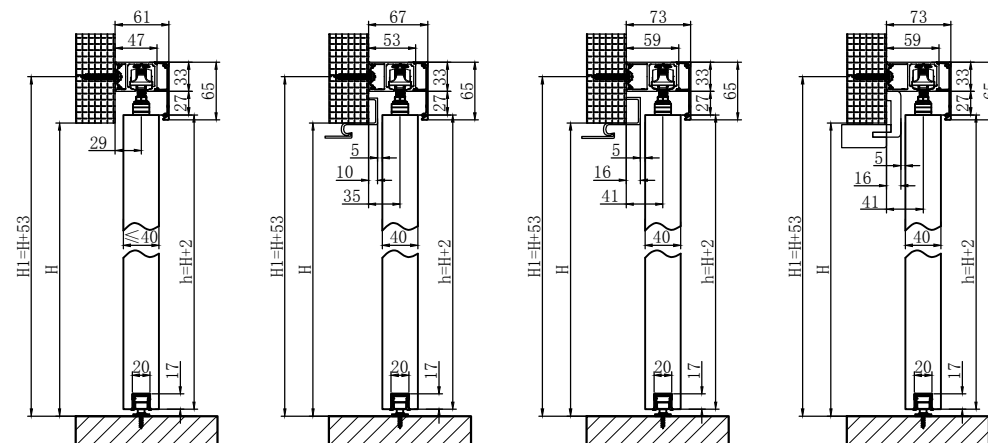

Door panel processing parameters/Tür Bearbeitungsparameter

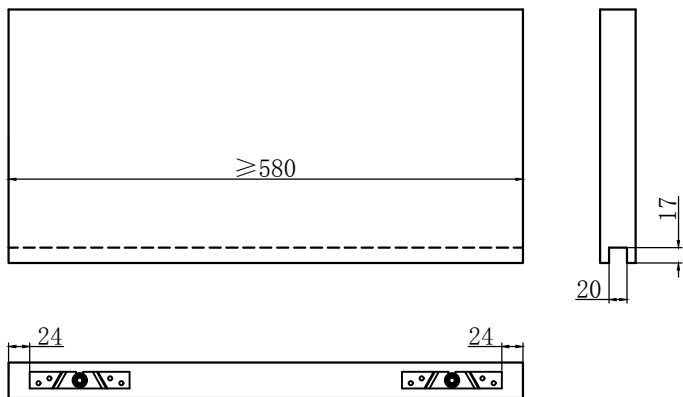

Running part with two-way damper/Laufwerk 2-Wege Dämpfer

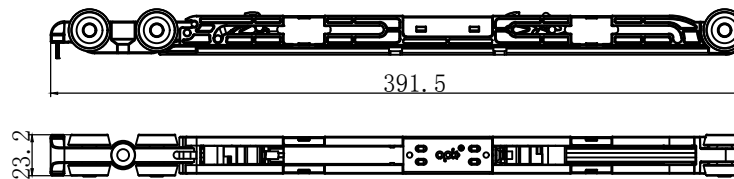

Running part(roller)/Laufwerk

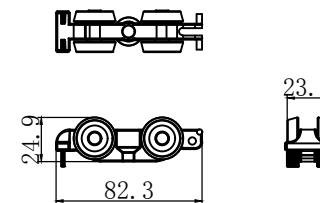

Suspension bracket wood/Aufhängung Holz

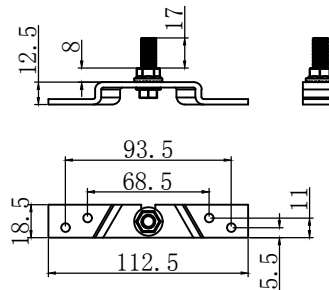

Activator/Aktivator

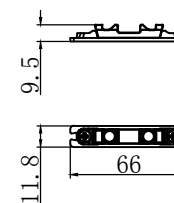

Floor guide 1 roller wood /Bodenführung 1 Rolle Holz

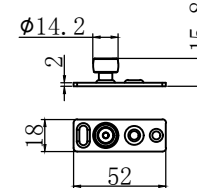

Door width calculation/Türbreitenberechnung

W: Door opening width

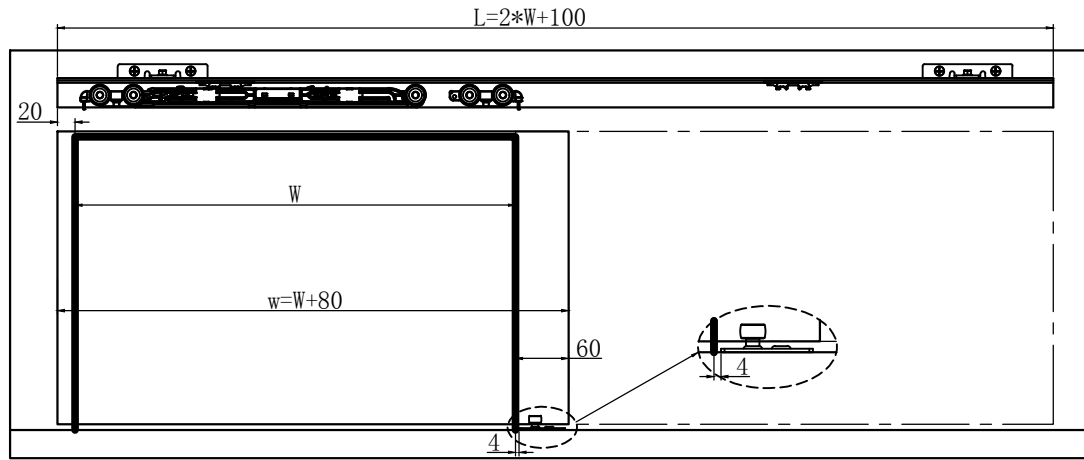

Installation instruction/Einbau Anleitung

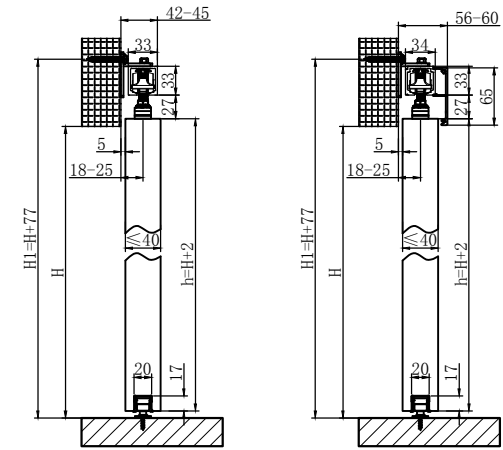

Door panel processing parameters/Tür Bearbeitungsparameter

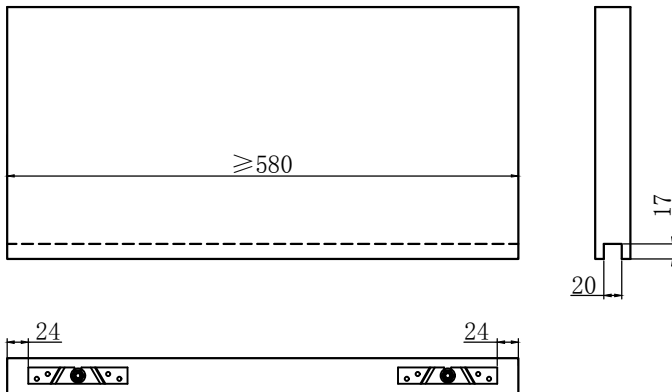

Running part with two-way damper/Laufwerk 2-Wege Dämpfer

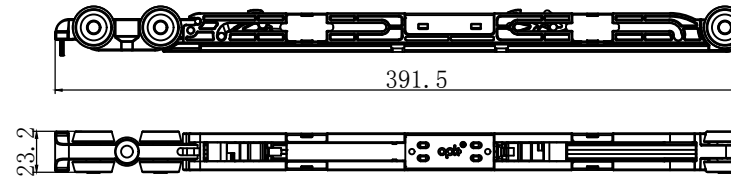

Running part(roller)/Laufwerk

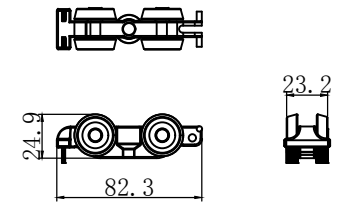

Suspension bracket wood/Aufhängung Holz

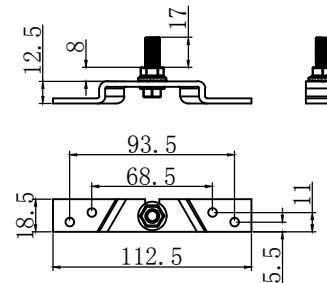

Activator/Aktivator

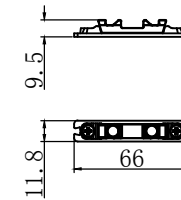

Floor guide 1 roller wood /Bodenführung 1 Rolle Holz

