

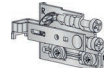

# SCARPI-4

## Colgadores de armario

Colgador de armarios de alta resistencia: 45Kg./unidad en bastidor tipo A y 35Kg./unidad en bastidor tipo B según EN 15939

- > Permite tres regulaciones independientes fácilmente accesibles desde el frente.
- > Queda oculto bajo una tapa extraplana en diversos colores.
- > Disponible para montaje a presión, con tirafondos, euro-screw.
- > Realizado en acero para permitir su posterior reciclaje.

<b>1</b>	SCARPI-4 .....		215
	■ Colgador SCARPI-4 .....		215
	■ Accesorios .....		216
<b>2</b>	SCARPI-4 con antivuelco .....		218
	■ Colgador SCARPI-4 con antivuelco .....		218
	■ Accesorios .....		219

**1 SCARPI-4**

**Colgador SCARPI-4**

Colgador de armarios m/tornillo euro-screw.

	Izquierda	Derecha	
Cincado	625.000.036	625.100.033	200

Se suministra con los tornillos euro-screw.

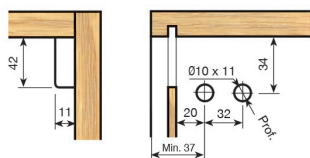

Colgador de armarios m/presión.

	Izquierda	Derecha	
Cincado	625.200.030	625.300.034	200

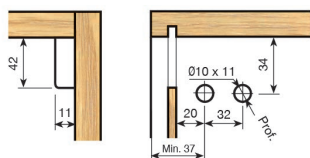

Colgador de armarios m/tirafondos.

	Izquierda	Derecha	
Cincado	625.400.031	625.500.035	200

Se suministrará con tirafondos de Ø5 x 16

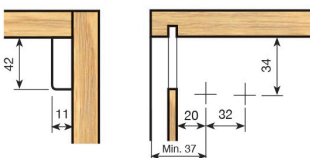

Tapa.

		Izquierda	Derecha	
Blanco	RAL 9001	639.600.006	639.700.003	400
Blanco	RAL 9003	639.600.135	639.700.132	
Gris		639.600.146	639.700.143	
Antracita	RAL 7043	639.600.312	639.700.316	
Niquelado*		639.200.063	639.300.060	

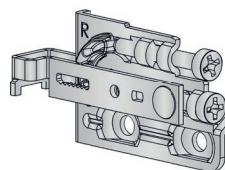

3 Regulaciones	
Altura	13mm.
Frontal	17mm.
Lateral	8mm.

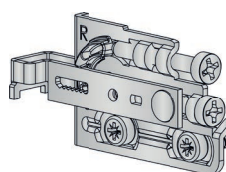
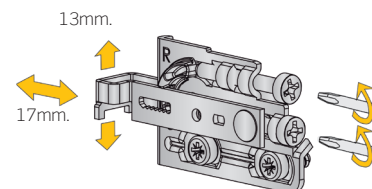

3 Regulaciones	
Altura	13mm.
Frontal	17mm.
Lateral	8mm.

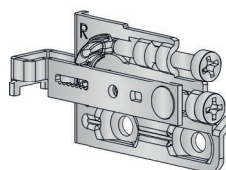

3 Regulaciones	
Altura	13mm.
Frontal	17mm.
Lateral	8mm.

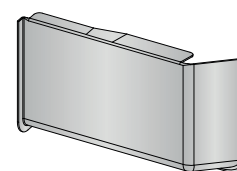
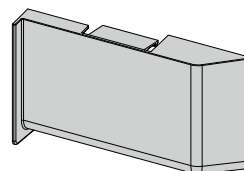

\* Niquelado

■ Accesorios

Bolsa de accesorios.

Cincado	620.400.105	200

En cajas de 200 bolsas. Cada bolsa contiene 1 enganche, 4 tacos de plástico de Ø8x40 y 4 tirafondos de Ø4,5x45.

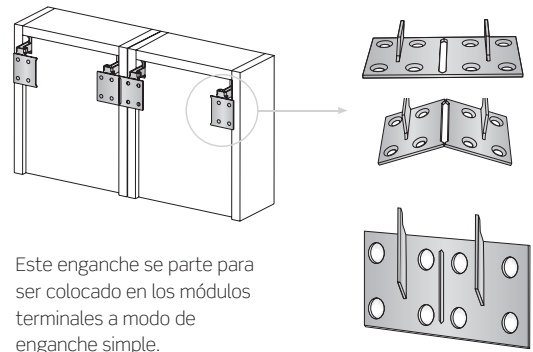

Este enganche se parte para ser colocado en los módulos terminales a modo de enganche simple.

Placa doble

Cincado	623.000.033	200

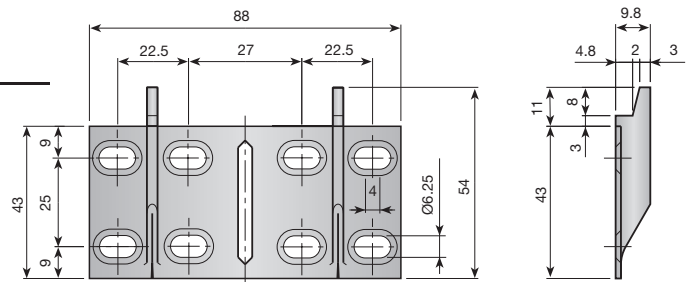

Tirafondos Ø4,5 x 35.

Cincado	982.435.031	5.000



Tacos de plástico Ø6 x 30.

Natural	662.130.302	1.000 ó 10.000

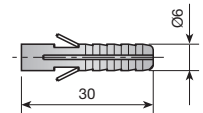

Tacos de plástico Ø8 x 40.

Natural	662.240.106	1.000 ó 10.000

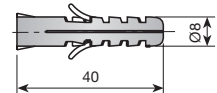

Escarpia con ranura.

Cincado	661.200.035	1.000

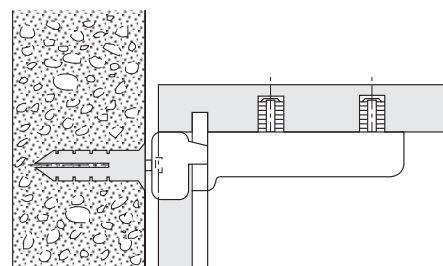
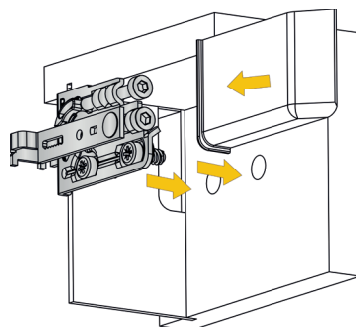
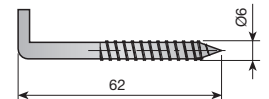

## 2 SCARPI-4 CON ANTIVUELCO

### Colgador SCARPI-4 con antivuelco

Colgador de armarios m/tornillo euro-screw con antivuelco para placa

	Izquierda	Derecha	
Cincado	629.800.032	629.900.036	200

Se suministra con los tornillos euro-screw.

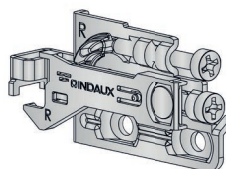
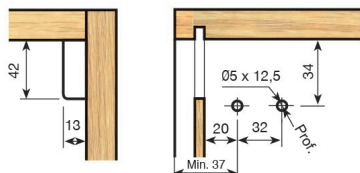

3 Regulaciones	
Altura	13mm.
Frontal	17mm.
Lateral	6mm.

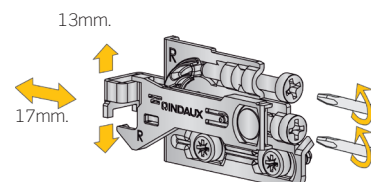

Colgador de armarios m/presión con antivuelco para placa

	Izquierda	Derecha	
Cincado	629.600.031	629.700.035	200

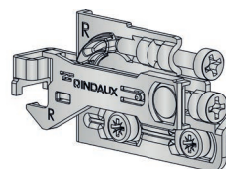
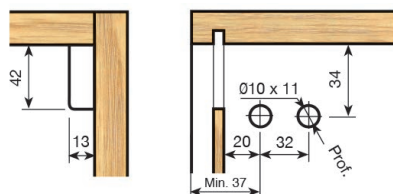

3 Regulaciones	
Altura	13mm.
Frontal	17mm.
Lateral	6mm.

Colgador de armarios m/tirafondos con antivuelco para placa

	Izquierda	Derecha	
Cincado	629.400.030	629.500.034	200

Se suministrará con tirafondos de Ø5 x 16

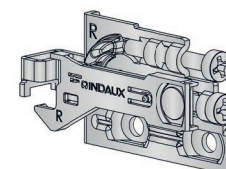
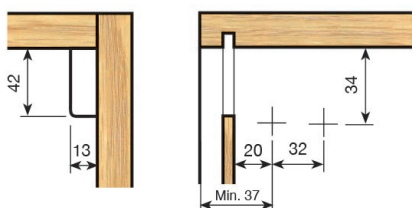

3 Regulaciones	
Altura	13mm.
Frontal	17mm.
Lateral	6mm.

Tapa para sistema antivuelco

		Izquierda	Derecha	
Blanco	RAL 9001	639.600.006	639.700.003	400
Blanco	RAL 9003	639.600.135	639.700.132	
Gris		639.600.146	639.700.143	
Antracita	RAL 7043	639.600.312	639.700.316	
Niquelado*		639.200.063	639.300.060	

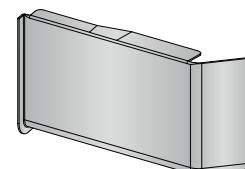
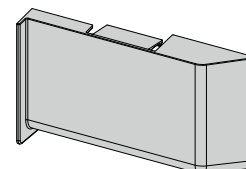

\* Niquelado

Antivuelco

	Izquierda	Derecha	
Para placa	629.000.492	629.100.496	200
Para escarpia	629.200.493	629.300.490	

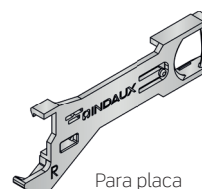

Para placa

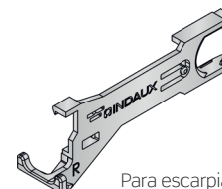

Para escarpia

■ Accesorios

Bolsa de accesorios.

Cincado	628.950.103		200
---------	-------------	---	-----

En cajas de 200 bolsas. Cada bolsa contiene 2 placas, 6 tacos de plástico de Ø8x40 y 6 tirafondos de Ø4,5x45.

Placa

Cincado	628.900.031		200
---------	-------------	---	-----

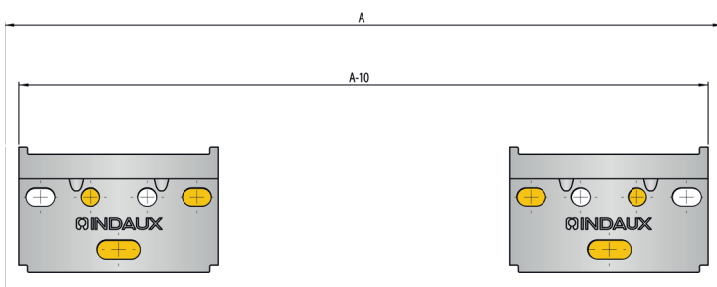
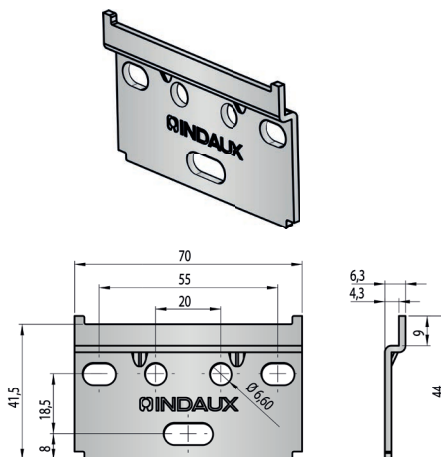

A: Ancho entre costados del módulo  
\* Los tirafondos deben colocarse en los agujeros indicados

Soporte colgador modular.

Módulo	L	Cincado	
200	158	623.315.033	150
250	208	623.320.036	150
300	258	623.325.032	150
350	308	623.330.035	100
400	358	623.335.031	100
450	408	623.340.034	100
500	458	623.345.030	52
550	508	623.350.033	52
600	558	623.355.036	52
650	608	623.360.032	52
700	658	623.365.035	52
750	708	623.370.031	52
800	758	623.375.034	52
900	858	623.385.033	40
1000	958	623.395.032	40
1200	1158	623.415.030	32
1350	1308	623.430.032	32

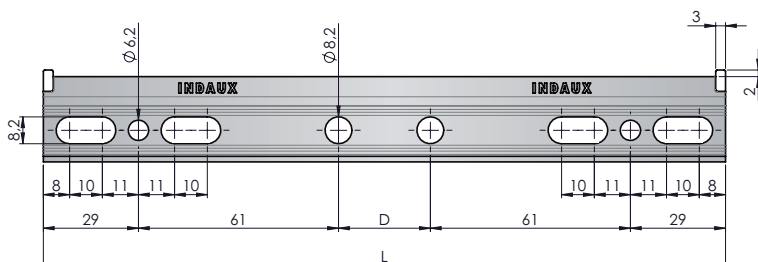

■ Accesorios

Tirafondos Ø4,5 x 35.

		
Cincado	982.435.031	5.000



Tacos de plástico Ø6 x 30.

		
Natural	662.130.302	1.000 ó 10.000

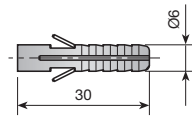

Tacos de plástico Ø8 x 40.

		
Natural	662.240.106	1.000 ó 10.000

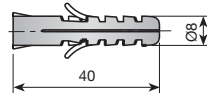

Escarpia con ranura.

		
Cincado	661.200.035	1.000

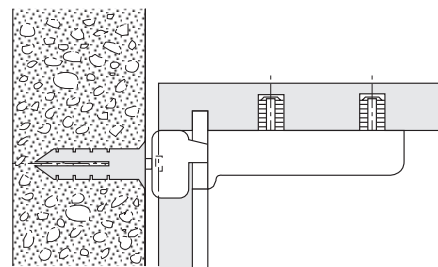
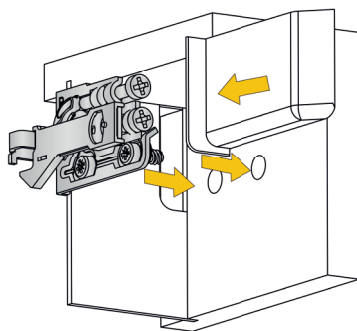
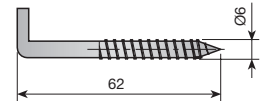



# SCARPI-5

## Colgadores de armario

Colgador de armarios de alta resistencia: 35Kg./  
unidad en bastidor tipo A según EN 15939.  
Disponible para montaje a presión ó con tirafondos.

<b>1</b>	<b>SCARPI-5</b> .....		222
	■ Colgador SCARPI-5 .....		223
	■ Accesorios .....		224



1 SCARPI-5

■ Colgador SCARPI-5

Colgador de armarios de alta resistencia: 35Kg./unidad en bastidor tipo A según EN 15939. Queda oculto bajo una tapa en diversos colores.

Colgador de armario montaje con tirafondos.

		Izquierdo	Derecho	
Blanco	RAL 9001	626.200.002	626.300.006	250
Blanco	RAL 9003	626.200.131	626.300.135	
Marrón	RAL 1011	626.200.190	626.300.194	

Fijación del colgador con 2 tirafondos de sujeción Ø3,5 x 16.

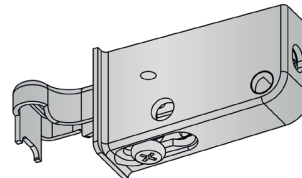
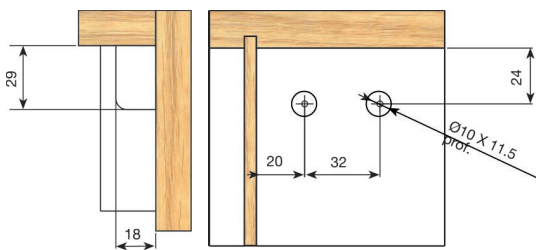

3 Regulaciones	
Altura	14mm.
Frontal	15mm.
Lateral	6mm.

Colgador de armario montaje a presión.

		Izquierdo	derecho	
Blanco	RAL 9001	626.400.003	626.500.000	250
Blanco	RAL 9003	626.400.132	626.500.136	

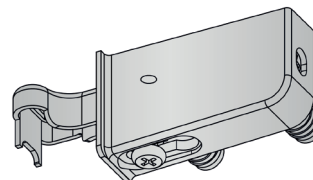
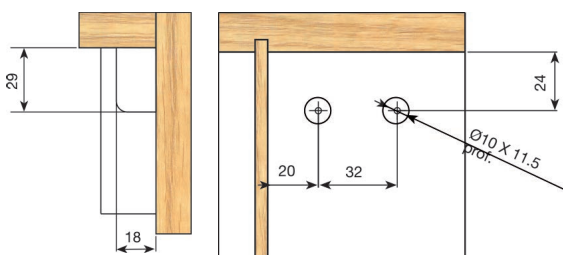

3 Regulaciones	
Altura	14mm.
Frontal	15mm.
Lateral	6mm.

■ Accesorios

Bolsa de accesorios.

620.400.105		200
-------------	---	-----

En cajas de 200 bolsas. Cada bolsa contiene 1 enganche, 4 tacos de plástico Ø8 x 40 y 4 tirafondos de Ø4,5 x 45.

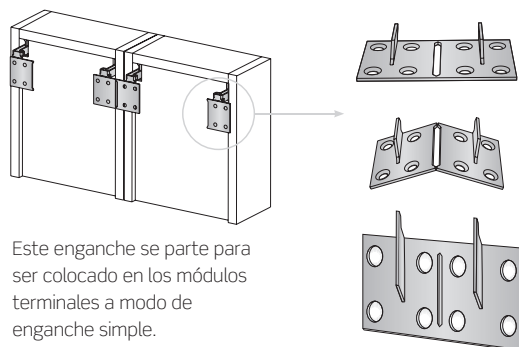

Este enganche se parte para ser colocado en los módulos terminales a modo de enganche simple.

Enganche doble.

Cincado	623.000.033		200
---------	-------------	---	-----

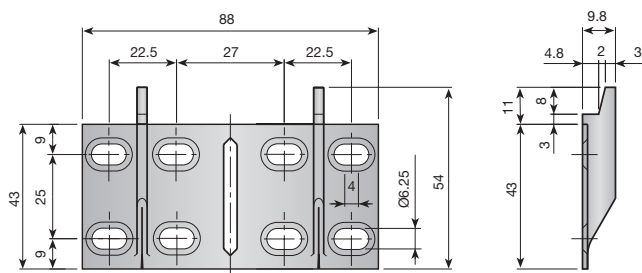

Placa

Cincado	626.700.034		200
---------	-------------	---	-----

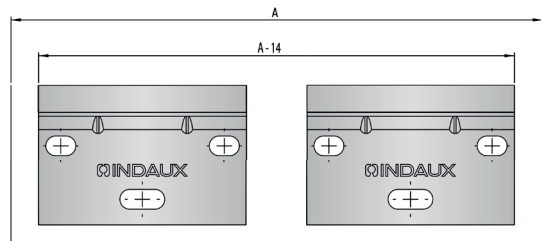
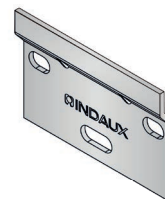
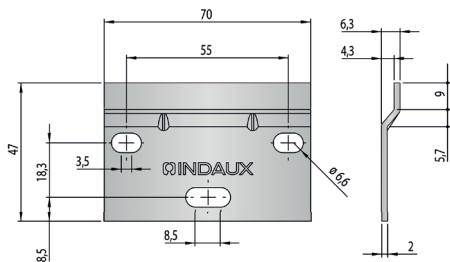

A: Ancho entre costados del módulo.

Soporte doble

Longitud (mm)	Cincado		200
110	626.800.031		

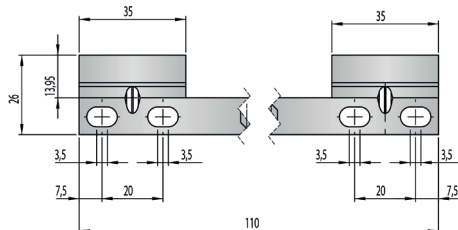
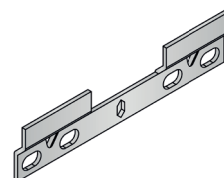
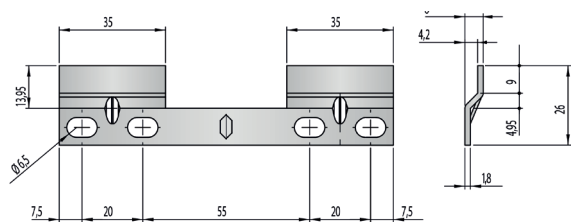

Tirafondos Ø4,5 x 35.

		
Cincado	982.435.031	5.000



Tacos de plástico Ø6 x 30.

		
Natural	662.130.302	1.000 ó 10.000

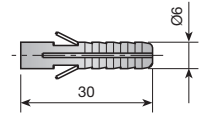

Tacos de plástico Ø8 x 40.

		
Natural	662.240.106	1.000 ó 10.000

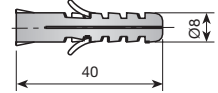

Escarpia con ranura.

		
Cincado	661.200.035	1.000

